

High reliability of fiber optic amplifier for convenient mounting

■ Features

- High speed response : Max. 0.5ms
- Auto sensitivity setting(Button setting)/Remote sensitivity setting
- External synchronization input, mutual interference protection, self-diagnosis
- Reverse power polarity and short-circuit(Overcurrent) protection circuit
- Timer function : Selectable None / 40ms OFF Delay timer(fixed)
(Standard type, remote sensitivity setting type only)
- Automatically selectable Light ON / Dark ON
- Precise detection of small target and complicated place to install



⚠ Please read "Caution for your safety" in operation manual before using.



■ Specifications

Model	Standard type				External synchronization input type		Remote sensitivity setting type	
	BF4RP	BF4GP	BF4R	BF4G	BF4R-E	BF4G-E	BF4R-R	BF4G-R
Response frequency	Max. 0.5ms(Frequency 1), Max. 0.7ms(Frequency 2)							
Power supply	12-24VDC ±10%(Ripple P-P: Max.10%)							
Current consumption	Max. 45mA							
Light source (modulated light)	Red	Green	Red	Green	Red	Green	Red	Green
Sensitivity adjustment	Sensitivity adjustment button(ON/OFF)							
Operation mode	Automatic selection of Light ON/Dark ON accordance with button setting							
Control output	NPN or PNP open collector output • Load voltage: Max. 30VDC • Load current: Max. 100mA • Residual voltage - NPN: Max. 1V(load current: 100mA), Max. 0.4V(load current:16mA) / PNP: Max. 2.5V							
Self-diagnosis output	ON state under unstable sensing(When the target stays for 300ms in unstable area), ON state when control output short-circuited • Load voltage: Max. 30VDC • Load current: Max. 50mA • Residual voltage - NPN: Max. 1V(load current: 50mA), Max. 0.4V(load current:16mA) / PNP: Max. 2.5V							
Protection circuit	Reverse power polarity, short-circuit(overcurrent) protection circuit							
Indicator	Operation indicator : Red LED, Stability indicator : Green LED ON when the target stays in stable sensing level							
Input of stop transmission function	—				Built-in		—	
External synchronization function	—				Built-in(Gate/Trigger)		—	
Remote sensitivity setting function	—				—		Built-in	
Interference prevention function※1	Built-in differential frequency mode (set by frequency 1 or 2 by ON/OFF button)							
Timer function (selectable)	Built-in OFF delay timer, Approx. 40ms fixed				—		Built-in OFF delay timer , Approx. 40ms fixed	
Ambient illumination	Sunlight : Max. 11,000lx, Incandescent lamp : Max. 3,000lx (Receiver illumination)							
Noise resistance	±240V the square wave noise(pulse width : 1μs) by the noise simulator							
Dielectric strength	1,000VAC 50/60Hz for 1 minute							
Insulation resistance	Min. 20MΩ(at 500VDC megger)							
Vibration	1.5mm amplitude or 300m/s ² at frequency of 10 to 55Hz(for 1 min.) in each of X, Y, Z directions for 2 hours							
Shock	500m/s ² (approx. 50G) in each of X, Y, Z directions for 3 times							
Environment	Ambient illumination	Sunlight : Max. 11000lx, Incandescent lamp : Max. 3000lx (received illumination)						
	Ambient temperature	-10 to 50°C, storage : -20 to 70°C						
	Ambient humidity	35 to 85% RH, storage :35 to 85% RH						
Material	Case : Heat-resistance ABS, Cover : PC							
Cable	Ø4, 4-wire, Length: 2m (AWG22, Core diameter: 0.08mm, Number of cores: 60, Insulator out diameter : Ø1.25mm)				Ø4, 6-wire, Length: 2m (AWG24, Core diameter: 0.08mm, Number of cores: 40, Insulator out diameter : Ø1mm)			
Accessory	Mounting bracket, Bolts/nuts							
Approval	CE							
Unit weight	Approx. 65g							

※1: Frequency 1(Normal mode) : Max. 0.5ms, Frequency 2 : Max. 0.7ms

※The temperature or humidity mentioned in Environment indicates a non freezing or condensation environment.

Fiber Optic Amplifier

Control output diagram

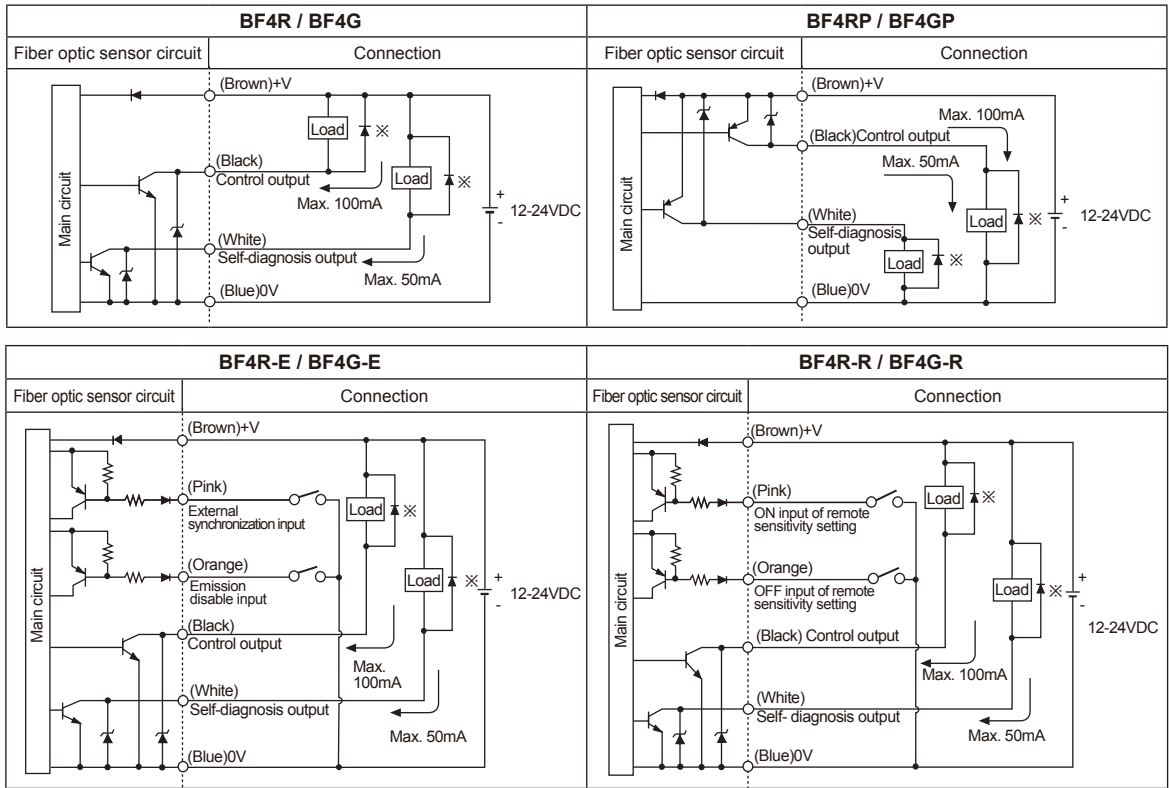

※Connect Diode at external terminal for inductive load.

Connections

• BF4R / BF4G

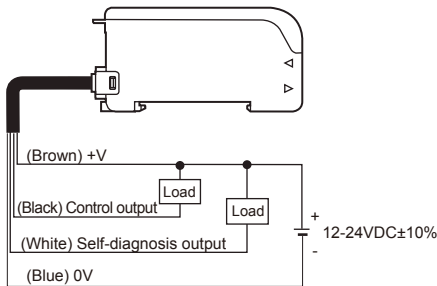

• BF4RP / BF4GP

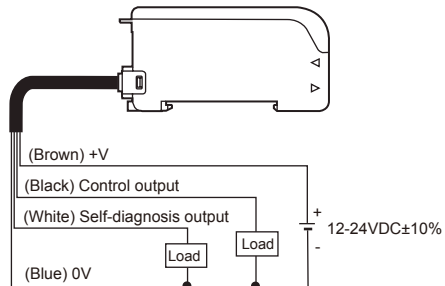

• BF4R-E / BF4G-E

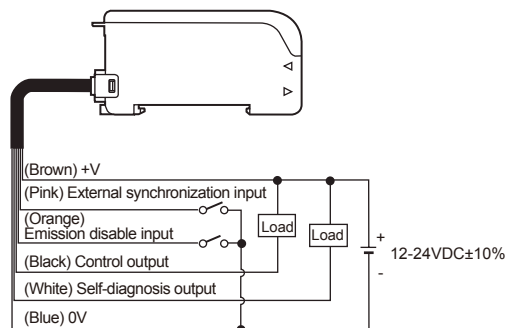

• BF4R-R / BF4G-R

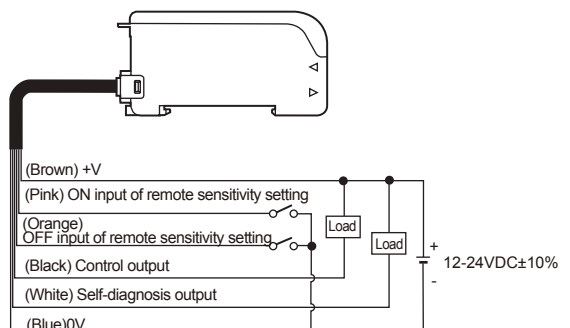

(A) Photo electric sensor

(B) Fiber optic sensor

(C) Door/Area sensor

(D) Proximity sensor

(E) Pressure sensor

(F) Rotary encoder

(G) Connector/Socket

(H) Temp. controller

(I) SSR/Power controller

(J) Counter

(K) Timer

(L) Panel meter

(M) Tacho/Speed/Pulse meter

(N) Display unit

(O) Sensor controller

(P) Switching mode power supply

(Q) Stepper motor& Driver&Controller

(R) Graphic/Logic panel

(S) Field network device

(T) Software

(U) Other

BF4 Series

(unit: mm)

■ Dimensions

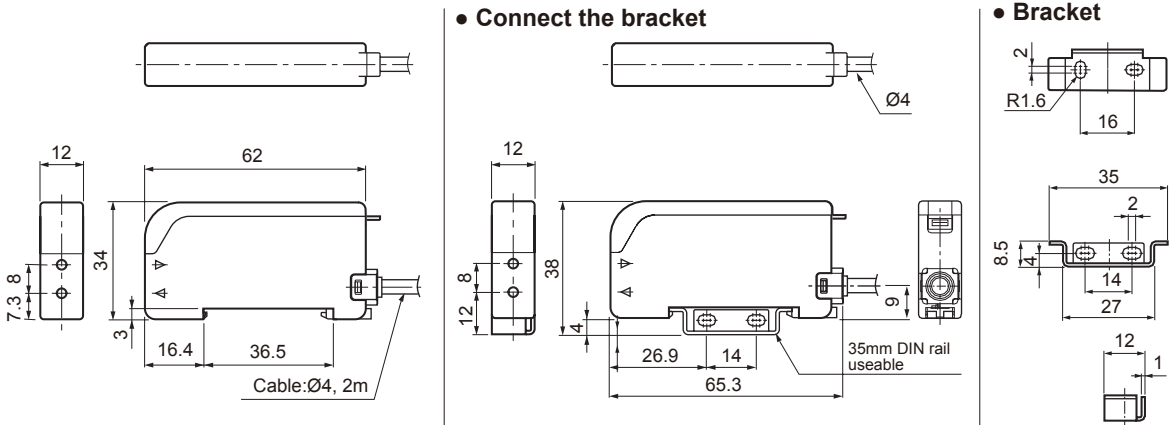

■ Installations

◎ Mounting amplifier unit

● When mounting the amplifier

- ① Hook the front part of the amplifier on DIN rail(or bracket).
- ② Press the rear part of the amplifier on DIN rail(or bracket).

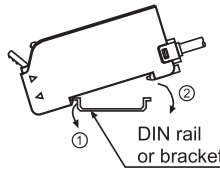

● When releasing the amplifier

Push the back of amplifier toward ③ and lift the hole for fiber toward ④ up then simply take it out without tools.

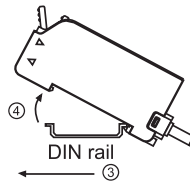

◎ Installation of fiber optic cable

● In case of using L bracket

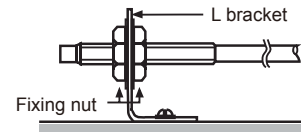

● In case of using screw

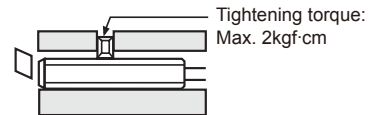

※Notice: If setting bolt is tightened with over specified tightening torque, hood of fiber optic cable may be damaged.

◎ Connection of fiber optic cable & amplifier

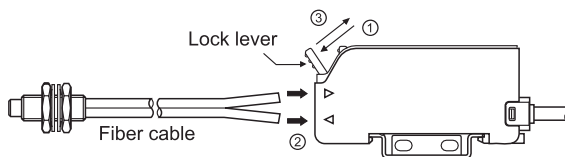

- ① Open the lock lever to "↙" direction.
- ② Insert the fiber optic cable in the amplifier slowly. (Depth: approx. 10mm)
- ③ Close the lock lever to "↗" direction.

■ Parts description

● BF4R / BF4G / BF4RP / BF4GP / BF4R-R / BF4G-R

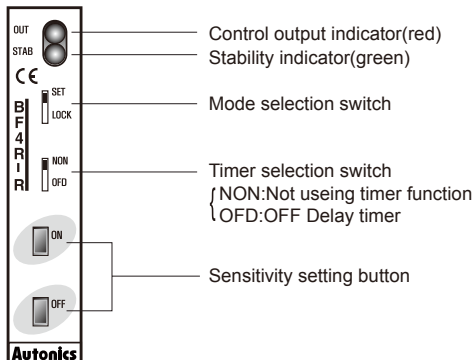

● BF4R-E / BF4G-E

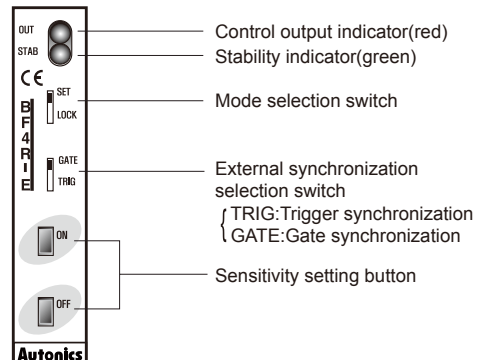

Setting mode

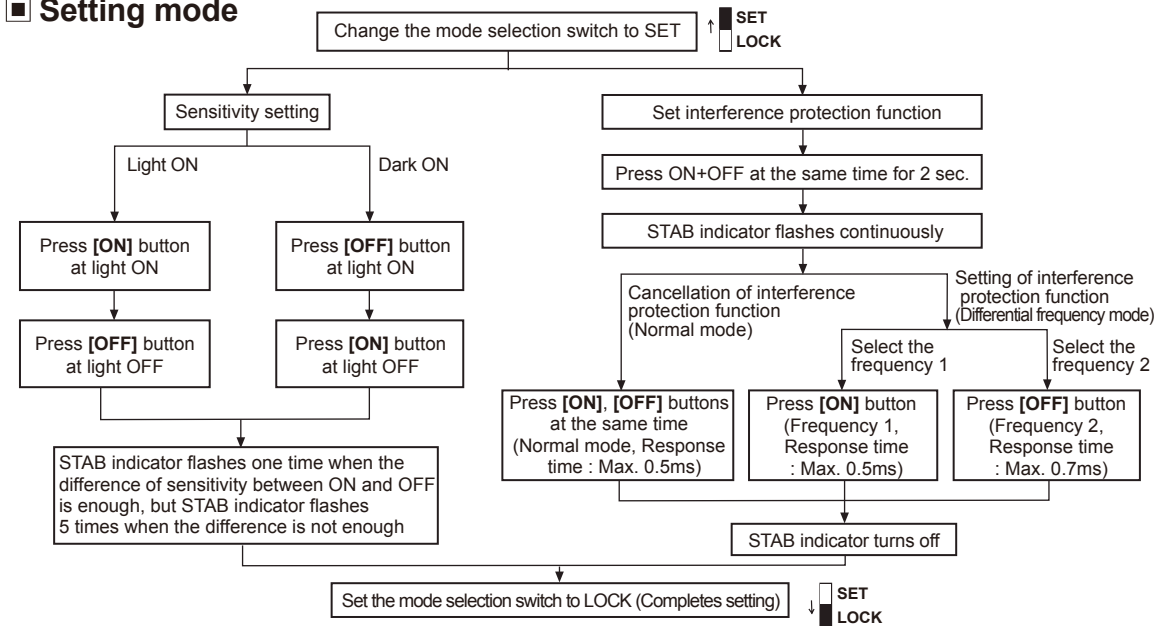

Sensitivity adjustment





Adjustment by the sensitivity setting button(Common)

Light ON

The control output turns on at Light ON status and turns off at Light OFF status.

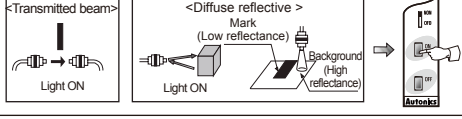
Dark ON

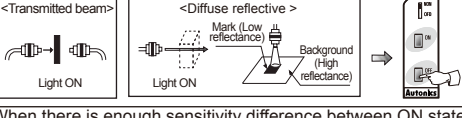
The control output turns off at Light ON status and turns on at Light OFF status.

Order	Setting method
①	Mount the fiber optic cable within sensing distance.
②	Change the mode selection switch to [SET]. 
③	Diffuse reflective: Press [ON] button with a sensing target. Transmitted beam: Press [ON] button without a sensing target. 
④	Stability indicator flashes at ON state. (Check the target position) 
⑤	Diffuse reflective: Press [OFF] button without a sensing target. Transmitted beam: Press [OFF] button with a sensing target. 
⑥	•When there is enough sensitivity difference between ON state and OFF state, the STAB indicator flashes one time only at stable sensing level. •When there is not enough sensitivity difference between ON state and OFF state, the STAB indicator flashes five times at unstable sensing level.*1
⑦	Change the mode selection switch to [LOCK], even though the sensitivity setting button is touched, setting sensitivity shall not be changed. 

*1. The sensitivity can be set at unstable sensing area.

※When the power is OFF, the set sensitivity is saved.

※After completing sensitivity setting, do not move or bend fiber cable. It may not detect it properly.

<How to set sensitivity>

Most of adjustments except ③ & ⑤ are same as Light ON mode.

- ③ state

Diffuse reflective: Press [ON] button without a sensing target.
Through-beam: Press [ON] button with a sensing target.

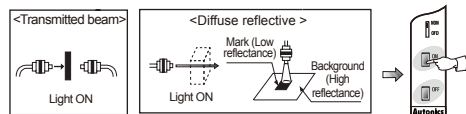

- ⑤ state

Diffuse reflective: Press [OFF] button with a sensing target.
Through-beam: Press [OFF] button without a sensing target.

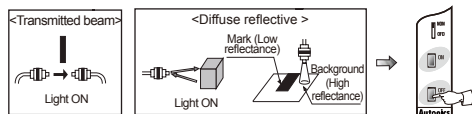

(A) Photo electric sensor

(B) Fiber optic sensor

(C) Door/Area sensor

(D) Proximity sensor

(E) Pressure sensor

(F) Rotary encoder

(G) Connector/Socket

(H) Temp. controller

(I) SSR/Power controller

(J) Counter

(K) Timer

(L) Panel meter

(M) Tacho/Speed/Pulse meter

(N) Display unit

(O) Sensor controller

(P) Switching mode power supply

(Q) Stepper motor& Driver&Controller

(R) Graphic/Logic panel

(S) Field network device

(T) Software

(U) Other

BF4 Series

◎ To set as max. sensitivity(Common)

- ① Execute the general sensitivity setting.
- ② Set the mode selection switch to [SET] mode.
- ③ If there is no sensing target,
 - **Light ON**: Press the [ON → OFF] button
 - **Dark ON**: Press the [OFF → ON] button
- ④ Set the mode selection switch to [LOCK] mode.

※External sensitivity setting

- **Light ON**(From above ③)
External sensitivity setting **ON** input(High→Low→High)
External sensitivity setting **OFF** input (High→Low→High)
- **Dark ON Mode**(From above ③)
External sensitivity setting **OFF** input(High→Low→High)
External sensitivity setting **ON** input(High→Low→High)

< Application >

- To extend sensing distance by the diffuse reflective type:
If fiber optic sensor is used in place where there are targets with high reflectivity and low reflectivity, it is able to get stable detection by adjusting max. sensitivity.
- When it is used as transmitted beam type at bad environment :
If fiber optic sensor is used in place where there is lots of dust or moisture, it might cause malfunction.
Please max. sensitivity then it can perform stable detection.

◎ Remote sensitivity adjustment[BF4R(G)-R]

BF4R-R/BF4G-R type can adjust the sensitivity with input signal lines regardless of the mode selection switch as following diagram ;

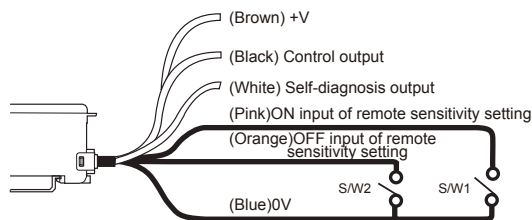

① Adjustment at Light ON

- ON input of remote sensitivity setting(SW1) :
SW1 turns on and then turns off instead of ③ state of adjustment by the sensitivity setting button.
- OFF input of remote sensitivity setting(SW2) :
SW2 turns on and then turns off instead of ⑤ state of adjustment by the sensitivity setting button.

② Adjustment at Dark ON

- OFF input of remote sensitivity setting(SW2) :
SW2 turns on and then turns off instead of ③ state of adjustment by the sensitivity setting button.
- ON input of remote sensitivity setting(SW1) :
SW1 turns on and then turns off instead of ⑤ state of adjustment by the sensitivity setting button.

<External sensitivity setting input signal condition>

State	Signal condition
High	4.5-30VDC or Open
Low	0-1VDC

*Input impedance:10kΩ

◎ Prohibition of inputting External sensitivity setting[BF4R(G)-R]

Even though mode switch is at Lock position, it is able to input external sensitivity setting when Switch1 and Switch 2 are ON. Therefore please install Switch3 in order to prevent from malfunction as below.

※SW3 - OFF : Disable to set external sensitivity

※SW3 - ON : Enable to set external sensitivity

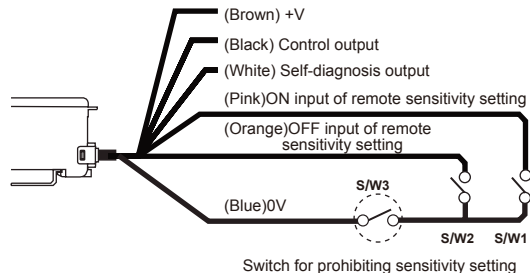

◎ Answer Back function[BF4R(G)-R]

When ON or OFF input of remote sensitivity setting is applied, after 300ms, self-diagnosis output turns on for 40ms and then the sensor keeps normal sensing state. (Note: Time chart)

※Self-diagnosis output does not turn on if there is no difference of sensitivity between ON input and OFF input and stable sensing is not executed, but stable sensing operates after 340ms.

<Time Chart : Light ON mode >

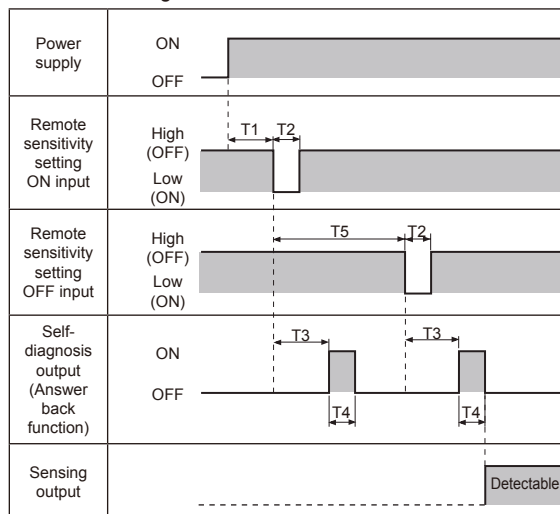

※During period T3(Approx. 300ms), do not change the light ON value by moving the object, etc.

1. T1≥1,000ms (After power turns on, it can be set after 1sec.)
2. T2≥5ms (ON or OFF input time of remote sensitivity setting must be min. 5ms)
3. T3=300ms (When ON or OFF input of remote sensitivity setting is applied, self-diagnosis output turns on after 300ms)
4. T4=40ms (ON time of self-diagnosis output)
5. T5≥500ms (When ON input of remote sensitivity setting is applied and then apply OFF input of remote sensitivity setting after 500ms)

OFF Delay timer function (BF4R/BF4RP/BF4R-R/BF4G/BF4GP/BF4G-R)

Standard type and Remote sensitivity setting type both contain a built-in approx. 40ms fixed OFF Delay timer. The timer works when the timer selection switch is set to 'OFD'. The output is turned off after remaining on for additional 40ms at OFF position of the sensing output. It is useful when the response time of the connected device is slow or when the sensing signal from a tiny object is too short.

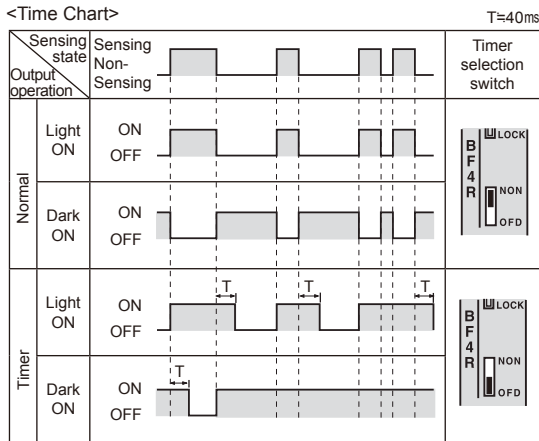

External synchronization input function [BF4R(G)-E]

By using external synchronization function, the time for making sensing can be specified by external synchronization. Trigger synchronization and gate synchronization are available.

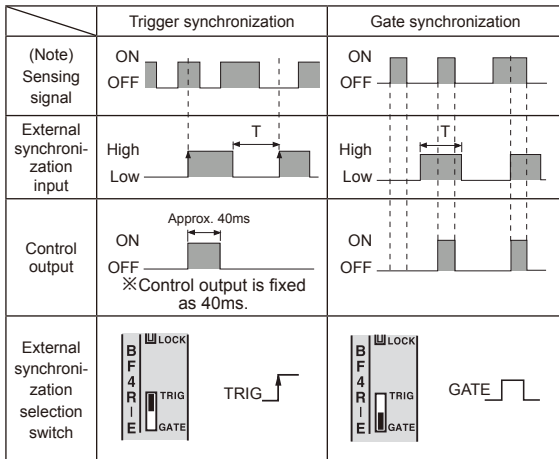

- ※ $T \geq 0.5\text{ms}$
(using interference prevention function: $T \geq 0.7\text{ms}$)
- ※ (Note) Actual signal detected by sensor.

<Input signal condition for External synchronization>

State	Signal condition
High	4.5-30VDC or Open
Low	0-1VDC

Stop transmission function [BF4R(G)-E]-Operation test

- Below test is available under Light ON state only.
- If input of stop transmission is at Low state, transmission light will be stopped.
- It can check normal or abnormal state of the sensor without moving the target.

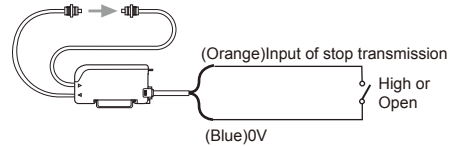

[If input of stop transmission is at High or Open state, light is transmitted.]

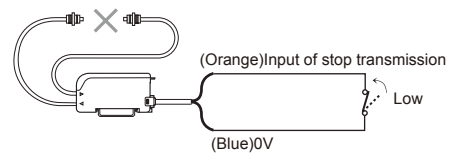

[If input of stop transmission is at Low, light is transmitted.]

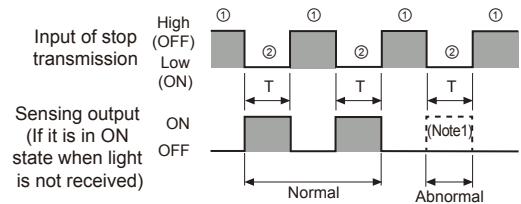

- ※ ①: Transmission area, ②: Stop transmission area
- ※ (Note1) If transmission is stopped control output must turn on, but if control output does not turn on, it seems that sensor has some problems.
- ※ $T \geq 0.5\text{ms}$
(When using interference prevention function $T \geq 0.7\text{ms}$)

<Input signal condition for Stop transmission>

State	Signal condition
High	4.5-30VDC or Open
Low	0-1VDC

(A) Photo electric sensor

(B) Fiber optic sensor

(C) Door/Area sensor

(D) Proximity sensor

(E) Pressure sensor

(F) Rotary encoder

(G) Connector/Socket

(H) Temp. controller

(I) SSR/Power controller

(J) Counter

(K) Timer

(L) Panel meter

(M) Tacho/Speed/Pulse meter

(N) Display unit

(O) Sensor controller

(P) Switching mode power supply

(Q) Stepper motor& Driver&Controller

(R) Graphic/Logic panel

(S) Field network device

(T) Software

(U) Other

■ Self-diagnosis function(Common)

When fiber hood is contaminated by dust, transmitted light is lowered by element ability loss or received light is lowered by missing of optical axis, the self-diagnosis output will turn on.

※Light ON mode

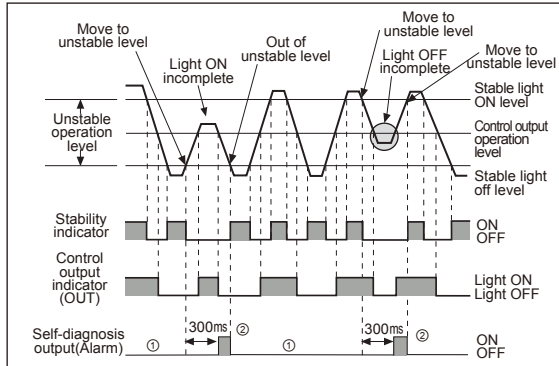

- ① The self-diagnosis output turns off during stable detection.(① position)
- ② When detecting state remains for 300ms at unstable level between stable light OFF level and stable light ON level, self diagnosis output turns on, self-diagnosis output turns off at lower than stable light OFF level and upper than stable light ON level. (② position)
- ③ When the control output turns on, if an overcurrent condition exists in control output, then self-diagnosis output turns on.

■ Interference prevention function (Common)

BF4R series has interference prevention function, two fiber optic cables can be mounted very closely by setting different transmission frequencies.

● Interference prevention function (Operation of differential frequency mode)

First sensor- Frequency 1(Response time: max. 0.5ms)

- ① Set the mode selection switch to [SET].
- ② Press the [ON] & [OFF] buttons for 2sec. at the same time.
- ③ The [STAB] indicator flashes continuously.
- ④ **Press the [ON] button.**
- ⑤ The [STAB] indicator turns off.

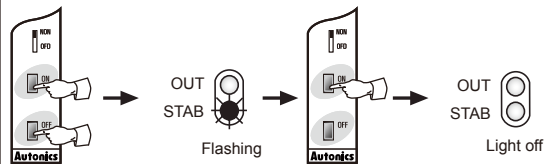

- ⑥ Set the mode selection switch to [LOCK].

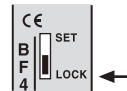

Second sensor- Frequency 2(Response time: max. 0.7ms)

- ① Set the mode selection switch to [SET].
- ② Press the [ON] & [OFF] buttons for 2sec. at the same time.
- ③ The [STAB] indicator flashes continuously.
- ④ **Press the [OFF] button.**
- ⑤ The [STAB] indicator turns off.

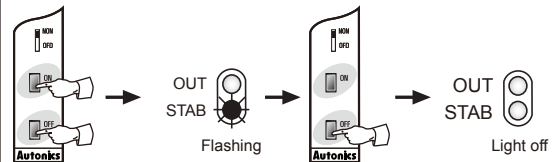

- ⑥ Set the mode selection switch to [LOCK].

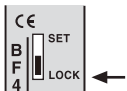

● Interference prevention function (Operation of normal mode)

- ① Set the mode selection switch to [SET].
 - ② Press the [ON] & [OFF] buttons for 2 sec. at the same time.
 - ③ The stable indicator flashes continuously.
 - ④ **Press the [ON] & [OFF] buttons at the same time.**
 - ⑤ The [STAB] indicator turns off.
 - ⑥ Set the mode selection switch to [LOCK].
- ※When interference prevention function is used, hysteresis & response time will be longer than normal operation(Response time : Max. 0.5ms).